

Product Category

89T-5-S

Part Description

Bulkhead

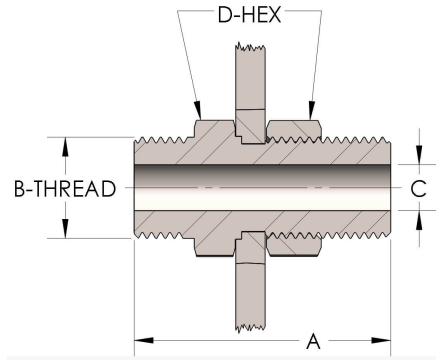

DIMENSIONS

A	2.940
B-THREAD	2.313" - 12UNS
C	0.81
D-HEX	2.75

GENERAL

Pressure Rating	6000 PSI
Threadpiece Material	Carbon Steel, ASTM A108