

Product Category

89T-6-SS316L

Part Description

Bulkhead

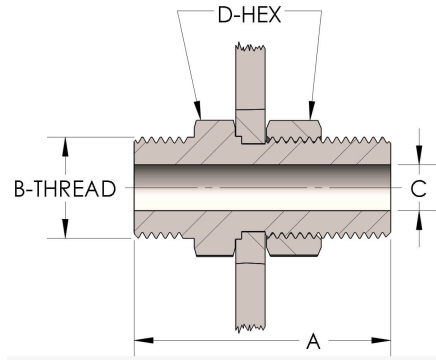

DIMENSIONS

A	2.940
B-THREAD	2.750" - 12UN
C	1.19
D-HEX	3.25

GENERAL

Pressure Rating	6000 PSI
Threadpiece Material	316/L Stainless Steel, ASTM A276, UNS S31600/03