

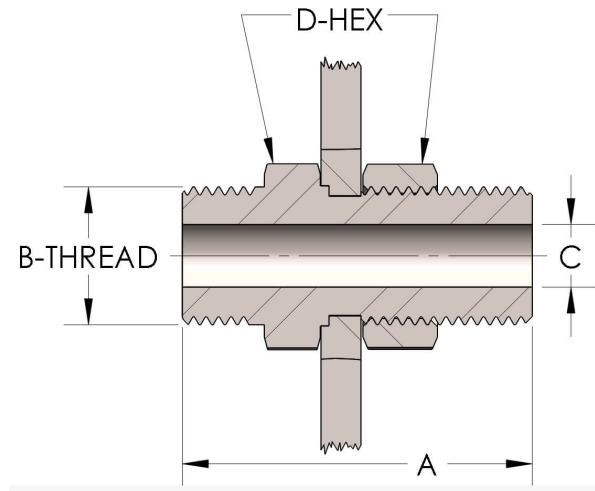

Product Category
Part Description

89T-8-SS316L
Bulkhead



DIMENSIONS

A	3.440
B-THREAD	3.750" - 12UN
C	1.75
D-HEX	4.25

GENERAL

Pressure Rating	6000 PSI
Threadpiece Material	316/L Stainless Steel, ASTM A276, UNS S31600/03

cpvmfg.com | 484.731.4010

The complete catalog contents must be reviewed to ensure that the system designer and user make a safe product selection. When selecting products, the total system design must be considered to ensure safe, trouble-free performance. Function, material compatibility, adequate ratings, proper installation, operation, and maintenance are the responsibilities of the system designer and user. Caution: Do not mix or interchange valve components with those of other manufacturers.