

Product Category

G0SGPS-06-NO

Product Line

FloMaster® Actuated G-Series® Shutoff Valves (G-S Series)

Part Description

Globe Shutoff Actuated Valve, Socketweld Pipe Ends, Normally Open

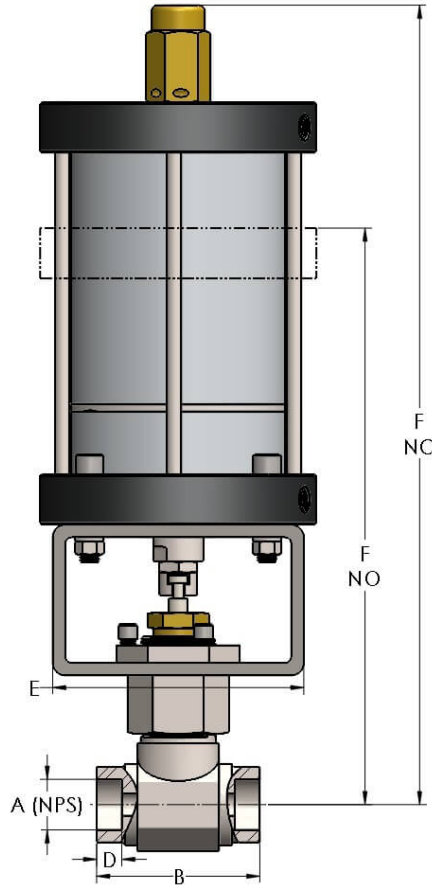

## DIMENSIONS

Orifice	0.218
A (NPS)	0.675
B	2.38
D	0.380
E	4.00
F (Normally Open)	6.19
F (Normally Closed)	10.63



## GENERAL

<b>Pressure Rating</b>	6000 PSI
<b>Temperature Range</b>	-15°F to 400°F (-26°C to 204°C)
<b>Standard Soft Goods</b>	[-G] Polyurethane® Packing and Viton® O-Rings
<b>Cartridge Type</b>	Shutoff
<b>Connection Type</b>	Socketweld Pipe
<b>Connection Size</b>	3/8"
<b>Body Material</b>	316/L Stainless Steel, ASTM A182, UNS S31603
<b>Bonnet Material</b>	316/L Stainless Steel, ASTM A276, UNS S31603

## OPTIONS

<b>[-VC] Vacuum Service</b>	Option to add additional softgoods for internal vacuum service.
<b>Optional Soft Goods</b>	[-B] Polyurethane® Packing and Buna-N O-Rings, [-C] Viton® Packing & O-Rings, [-D] EPDM Packing & O-Rings