



Product Category

G1CGPF-08

Product Line

G-Series® Check Valves (G-C Series)

Part Description

Globe Check Valve with Female Pipe Thread (NPT) Ends

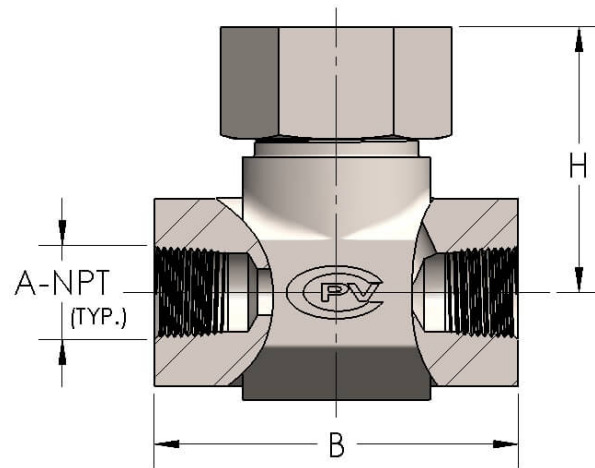

## DIMENSIONS

Orifice	0.313
A-NPT :	1/2"-14
B	3.13
H	2.06

## GENERAL

Pressure Rating	6000 PSI
Temperature Range	-15°F to 400°F (-26°C to 204°C)
Standard Soft Goods	[-G] Polyurethane® Packing and Viton® O-Rings
Cartridge Type	Check
Connection Type	Female Pipe Thread (NPT)
Connection Size	1/2"
Body Material	316/L Stainless Steel, ASTM A182, UNS S31603
Bonnet Material	316/L Stainless Steel, ASTM A276, UNS S31603

## OPTIONS

**[-VC] Vacuum Service**

Option to add additional softgoods for internal vacuum service.

**Optional Soft Goods**

[-B] Polyurethane® Packing and Buna-N O-Rings, [-C] Viton® Packing & O-Rings, [-D] EPDM Packing & O-Rings

[cpvmfg.com](http://cpvmfg.com) | 484.731.4010

The complete catalog contents must be reviewed to ensure that the system designer and user make a safe product selection. When selecting products, the total system design must be considered to ensure safe, trouble-free performance. Function, material compatibility, adequate ratings, proper installation, operation, and maintenance are the responsibilities of the system designer and user. Caution: Do not mix or interchange valve components with those of other manufacturers.