



Product Category

Product Line

Part Description

G1NGPS-08

G-Series® Needle Valve (G-N Series)

Globe Needle Valve with Socketweld Pipe Ends

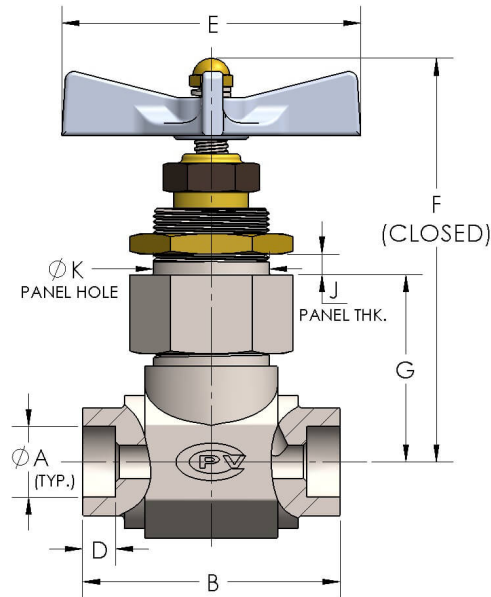

DIMENSIONS

Orifice	0.313
A (NPS)	0.840
B	2.75
D	0.380
E	3.50
F	4.56
G	1.81
J (max.)	0.44
K	1.2

GENERAL

Pressure Rating	6000 PSI
Temperature Range	-15°F to 400°F (-26°C to 204°C)

Standard Soft Goods	[-G] Polyurethane® Packing and Viton® O-Rings
Cartridge Type	Needle
Connection Type	Socketweld Pipe
Connection Size	1/2"
Body Material	316/L Stainless Steel, ASTM A182, UNS S31603
Bonnet Material	316/L Stainless Steel, ASTM A276, UNS S31603

OPTIONS

[-VC] Vacuum Service	Option to add additional softgoods for internal vacuum service.
Optional Soft Goods	[-B] Polyurethane® Packing and Buna-N O-Rings, [-C] Viton® Packing & O-Rings, [-D] EPDM Packing & O-Rings

cpvmfg.com | 484.731.4010

The complete catalog contents must be reviewed to ensure that the system designer and user make a safe product selection. When selecting products, the total system design must be considered to ensure safe, trouble-free performance. Function, material compatibility, adequate ratings, proper installation, operation, and maintenance are the responsibilities of the system designer and user. Caution: Do not mix or interchange valve components with those of other manufacturers.