

Product Category

G3CGPF-08

Product Line

G-Series® Check Valves (G-C Series)

Part Description

Globe Check Valve with Female Pipe Thread (NPT) Ends

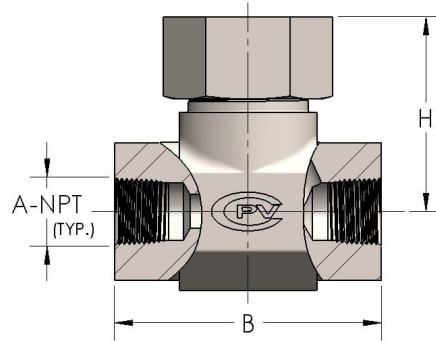

## DIMENSIONS

Orifice	0.500
A-NPT :	1/2"-14
B	3.88
H	2.88

## GENERAL

Pressure Rating	6000 PSI
Temperature Range	-15°F to 400°F (-26°C to 204°C)
Standard Soft Goods	[-G] Polyurethane® Packing and Viton® O-Rings
Cartridge Type	Check
Connection Type	Female Pipe Thread (NPT)
Connection Size	1/2"
Body Material	316/L Stainless Steel, ASTM A182, UNS S31603
Bonnet Material	316/L Stainless Steel, ASTM A276, UNS S31603



## OPTIONS

<b>[-VC] Vacuum Service</b>	Option to add additional softgoods for internal vacuum service.
<b>Optional Soft Goods</b>	[-B] Polyurethane® Packing and Buna-N O-Rings, [-C] Viton® Packing & O-Rings, [-D] EPDM Packing & O-Rings