

Product Category

G3CGPS-12

Product Line

G-Series® Check Valves (G-C Series)

Part Description

Globe Check Valve with Socketweld Pipe Ends

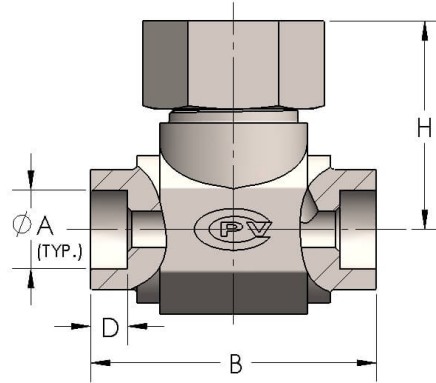

## DIMENSIONS

Orifice	0.500
A (NPS)	1.050
B	3.88
D	0.500
H	2.88

## GENERAL

Pressure Rating	6000 PSI
Temperature Range	-15°F to 400°F (-26°C to 204°C)
Standard Soft Goods	[-G] Polyurethane® Packing and Viton® O-Rings
Cartridge Type	Check
Connection Type	Socketweld Pipe
Connection Size	3/4"
Body Material	316/L Stainless Steel, ASTM A182, UNS S31603
Bonnet Material	316/L Stainless Steel, ASTM A276, UNS S31603



## OPTIONS

**[-VC] Vacuum Service**

Option to add additional softgoods for internal vacuum service.

**Optional Soft Goods**

[-B] Polyurethane® Packing and Buna-N O-Rings, [-C] Viton® Packing & O-Rings, [-D] EPDM Packing & O-Rings