

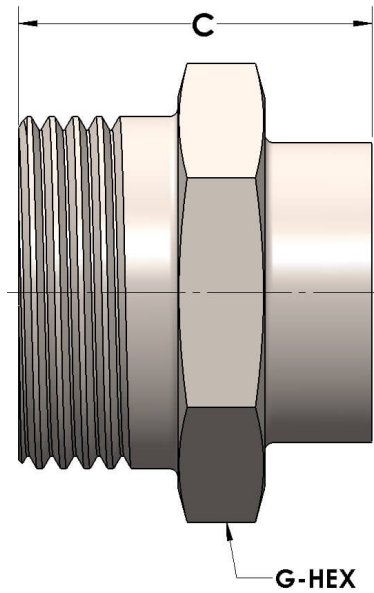

**Product Category**  
**Part Description**

H804T-06-SS316L  
Blank Threadpiece



## DIMENSIONS

<b>C</b>	0.81
<b>G-HEX</b>	0.75

## GENERAL

<b>Pressure Rating</b>	6000 PSI
<b>Threadpiece Material</b>	316/L Stainless Steel, ASTM A276, UNS S31600/03
<b>O-Ring Material</b>	Viton® Fluorocarbon Type 1, Class 2 (90 durometer)

cpvmfg.com | 484.731.4010

The complete catalog contents must be reviewed to ensure that the system designer and user make a safe product selection. When selecting products, the total system design must be considered to ensure safe, trouble-free performance. Function, material compatibility, adequate ratings, proper installation, operation, and maintenance are the responsibilities of the system designer and user. Caution: Do not mix or interchange valve components with those of other manufacturers.