

Product Category  
Part Description

H804T-10-S  
Blank Threadpiece

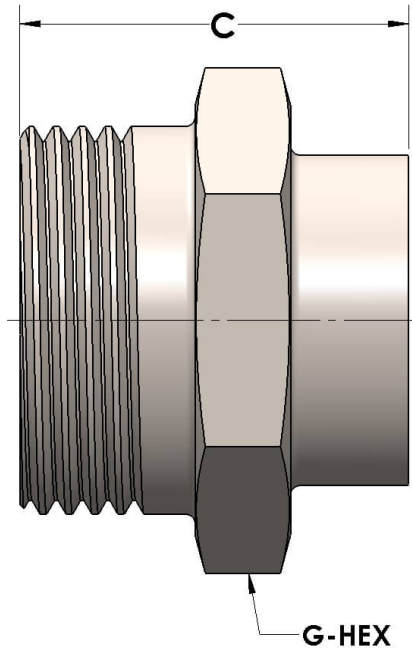

**DIMENSIONS**

<b>C</b>	1.06
<b>G-HEX</b>	1.06

**GENERAL**

<b>Pressure Rating</b>	6000 PSI
<b>Threadpiece Material</b>	Carbon Steel, ASTM A108
<b>O-Ring Material</b>	Viton® Fluorocarbon Type 1, Class 2 (90 durometer)