



Product Category

Part Description

H805-08-M

Straight Thread Plug

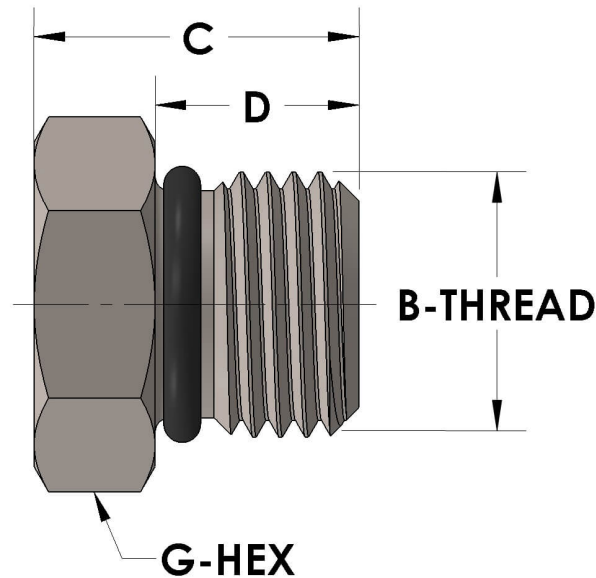

DIMENSIONS

| | |
|-----------------|---------------|
| B-THREAD | .750" - 16UNF |
| C | 0.75 |
| D | 0.470 |
| G-HEX | 0.88 |

GENERAL

| | |
|-----------------------------|--|
| Pressure Rating | 6000 PSI |
| Threadpiece Material | Monel®, ASTM B164, UNS N04405 |
| O-Ring Material | Viton® Fluorocarbon Type 1, Class 2 (90 durometer) |

The complete catalog contents must be reviewed to ensure that the system designer and user make a safe product selection. When selecting products, the total system design must be considered to ensure safe, trouble-free performance. Function, material compatibility, adequate ratings, proper installation, operation, and maintenance are the responsibilities of the system designer and user. Caution: Do not mix or interchange valve components with those of other manufacturers.