

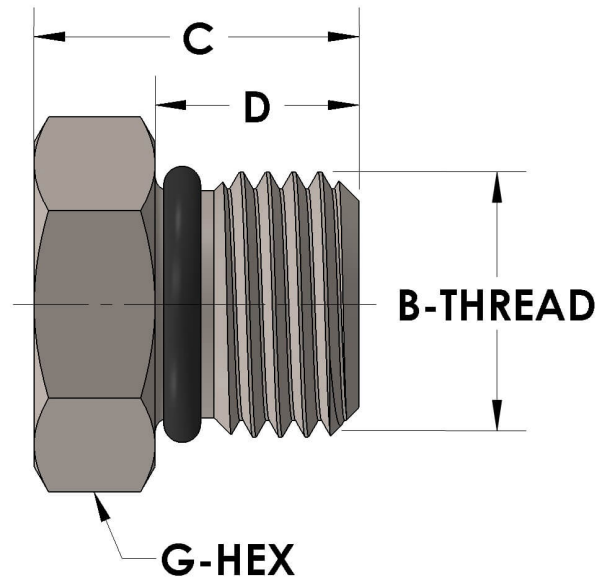

Product Category
Part Description

H805-08-SS316L
Straight Thread Plug



DIMENSIONS

B-THREAD	.750" - 16UNF
C	0.75
D	0.470
G-HEX	0.88

GENERAL

Pressure Rating	6000 PSI
Threadpiece Material	316/L Stainless Steel, ASTM A276, UNS S31600/03
O-Ring Material	Viton® Fluorocarbon Type 1, Class 2 (90 durometer)

The complete catalog contents must be reviewed to ensure that the system designer and user make a safe product selection. When selecting products, the total system design must be considered to ensure safe, trouble-free performance. Function, material compatibility, adequate ratings, proper installation, operation, and maintenance are the responsibilities of the system designer and user. Caution: Do not mix or interchange valve components with those of other manufacturers.