

Product Category

H805-16-SS316L

Part Description

Straight Thread Plug

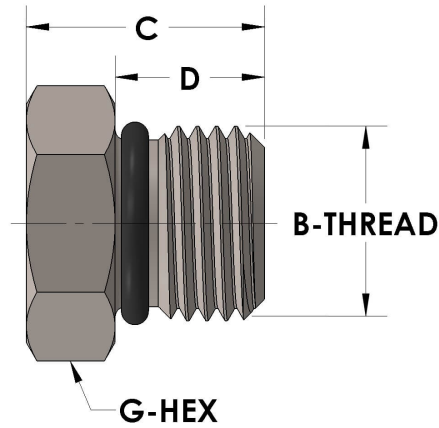

DIMENSIONS

B-THREAD	1.313" - 12UN
C	1.00
D	0.630
G-HEX	1.5

GENERAL

Pressure Rating	6000 PSI
Threadpiece Material	316/L Stainless Steel, ASTM A276, UNS S31600/03
O-Ring Material	Viton® Fluorocarbon Type 1, Class 2 (90 durometer)