

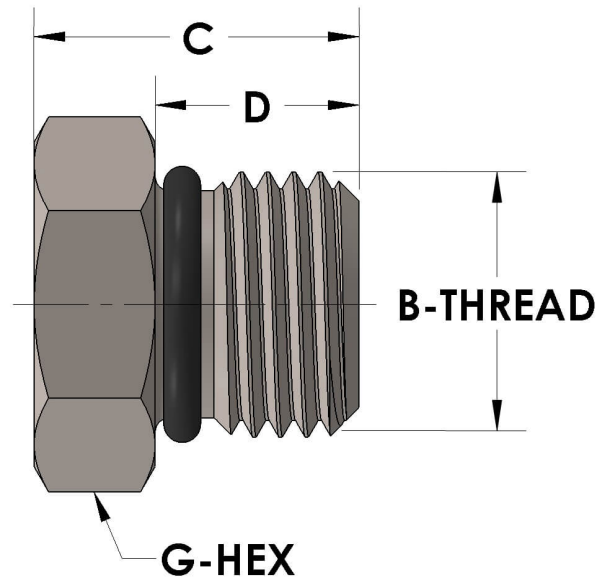

Product Category
Part Description

H805-24-M
Straight Thread Plug



DIMENSIONS

B-THREAD	1.875" - 12UN
C	1.00
D	0.630
G-HEX	2.13

GENERAL

Pressure Rating	6000 PSI
Threadpiece Material	Monel®, ASTM B164, UNS N04405
O-Ring Material	Viton® Fluorocarbon Type 1, Class 2 (90 durometer)

The complete catalog contents must be reviewed to ensure that the system designer and user make a safe product selection. When selecting products, the total system design must be considered to ensure safe, trouble-free performance. Function, material compatibility, adequate ratings, proper installation, operation, and maintenance are the responsibilities of the system designer and user. Caution: Do not mix or interchange valve components with those of other manufacturers.