

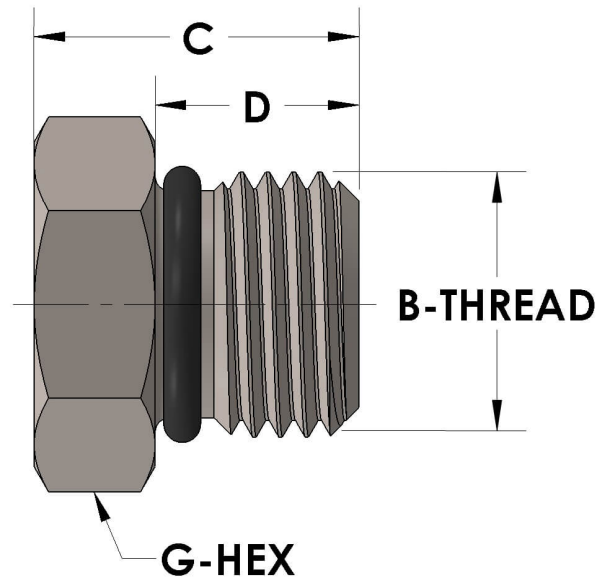

Product Category
Part Description

H805-32-SS316L
Straight Thread Plug



DIMENSIONS

B-THREAD	2.500" - 12UN
C	1.44
D	0.630
G-HEX	2.75

GENERAL

Pressure Rating	4500 PSI
Threadpiece Material	316/L Stainless Steel, ASTM A276, UNS S31600/03
O-Ring Material	Viton® Fluorocarbon Type 1, Class 2 (90 durometer)

The complete catalog contents must be reviewed to ensure that the system designer and user make a safe product selection. When selecting products, the total system design must be considered to ensure safe, trouble-free performance. Function, material compatibility, adequate ratings, proper installation, operation, and maintenance are the responsibilities of the system designer and user. Caution: Do not mix or interchange valve components with those of other manufacturers.