

Product Category

H809-06-M

Part Description

Socketweld/braze Tube Cross Assembly

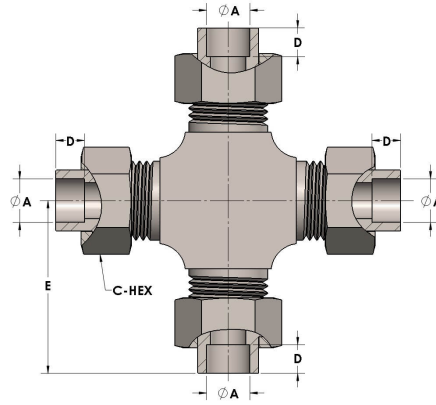

DIMENSIONS

A	0.380
C-HEX	0.81
D	0.250
E	1.50



GENERAL

Pressure Rating	6000 PSI
Tailpiece Material	Monel®, ASTM B164, UNS N04405
Threadpiece Material	Monel®, ASTM B564, UNS N04400
O-Ring Material	Viton® Fluorocarbon Type 1, Class 2 (90 durometer)
Connection 1 Type	Female Tube Socket
Connection 1 Size	3/8" Tube O.D. (-06)
Connection 2 Type	Female Tube Socket
Connection 2 Size	3/8" Tube O.D. (-06)
Connection 3 Type	Female Tube Socket
Connection 3 Size	3/8" Tube O.D. (-06)
Connection 4 Type	Female Tube Socket
Connection 4 Size	3/8" Tube O.D. (-06)