

Product Category

H810-08-08-06-S

Part Description

Socketweld/braze Tube Tee Assembly

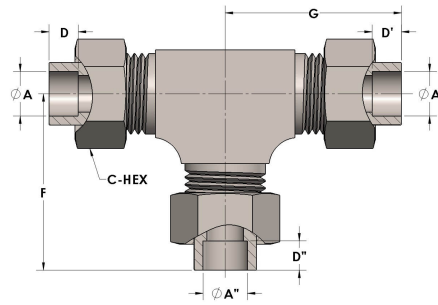

DIMENSIONS

A	0.500
A'	0.500
A''	0.380
C-HEX	0.94
D	0.310
D'	0.310
D''	0.250
F	1.69
G	1.69



GENERAL

Pressure Rating	4500 PSI
Assembly Material	Carbon Steel, ASTM A108
O-Ring Material	Viton® Fluorocarbon Type 1, Class 2 (90 durometer)
Connection 1 Type	Female Tube Socket
Connection 1 Size	1/2" Tube O.D. (-08)
Connection 2 Type	Female Tube Socket
Connection 2 Size	1/2" Tube O.D. (-08)
Connection 3 Type	Female Tube Socket
Connection 3 Size	3/8" Tube O.D. (-06)