

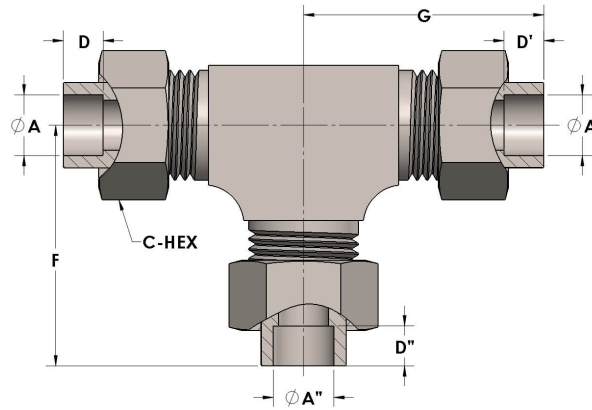

Product Category
Part Description

H810-08-08-06-S
Socketweld/braze Tube Tee Assembly



DIMENSIONS

A	0.500
A''	0.500
A'''	0.380
C-HEX	0.94
D	0.310
D''	0.310
D'''	0.250
F	1.69
G	1.69

GENERAL

Pressure Rating	4500 PSI
Assembly Material	Carbon Steel, ASTM A108
O-Ring Material	Viton® Fluorocarbon Type 1, Class 2 (90 durometer)
Connection 1 Type	Female Tube Socket
Connection 1 Size	1/2" Tube O.D. (-08)
Connection 2 Type	Female Tube Socket
Connection 2 Size	1/2" Tube O.D. (-08)
Connection 3 Type	Female Tube Socket

The complete catalog contents must be reviewed to ensure that the system designer and user make a safe product selection. When selecting products, the total system design must be considered to ensure safe, trouble-free performance. Function, material compatibility, adequate ratings, proper installation, operation, and maintenance are the responsibilities of the system designer and user. Caution: Do not mix or interchange valve components with those of other manufacturers.