

Product Category

H810-10-S

Part Description

Socketweld/braze Tube Tee Assembly

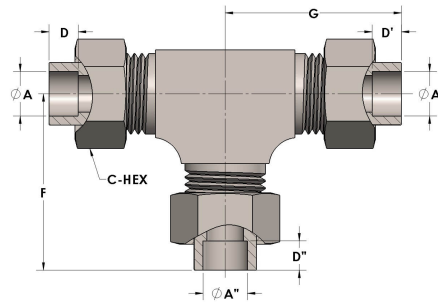

DIMENSIONS

A	0.630
A'	0.630
A''	0.630
C-HEX	1.13
D	0.380
D'	0.380
D''	0.380
F	2.06
G	2.06



GENERAL

Pressure Rating	4500 PSI
Assembly Material	Carbon Steel, ASTM A108
O-Ring Material	Viton® Fluorocarbon Type 1, Class 2 (90 durometer)
Connection 1 Type	Female Tube Socket
Connection 1 Size	5/8" Tube O.D. (-10)
Connection 2 Type	Female Tube Socket
Connection 2 Size	5/8" Tube O.D. (-10)
Connection 3 Type	Female Tube Socket
Connection 3 Size	5/8" Tube O.D. (-10)