



Product Category

H810-12-M

Part Description

Socketweld/braze Tube Tee Assembly

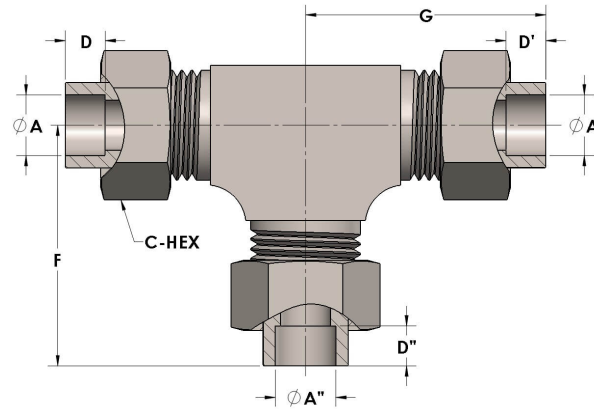

## DIMENSIONS

A	0.750
A''	0.750
A'''	0.750
C-HEX	1.38
D	0.440
D''	0.440
D'''	0.440
F	2.25
G	2.25

## GENERAL

Pressure Rating	6000 PSI
Tailpiece Material	Monel®, ASTM B164, UNS N04405
Threadpiece Material	Monel®, ASTM B564, UNS N04400
O-Ring Material	Viton® Fluorocarbon Type 1, Class 2 (90 durometer)
Connection 1 Type	Female Tube Socket
Connection 1 Size	3/4" Tube O.D. (-12)
Connection 2 Type	Female Tube Socket
Connection 2 Size	3/4" Tube O.D. (-12)

<b>Connection 3 Type</b>	Female Tube Socket
<b>Connection 3 Size</b>	3/4" Tube O.D. (-12)

The complete catalog contents must be reviewed to ensure that the system designer and user make a safe product selection. When selecting products, the total system design must be considered to ensure safe, trouble-free performance. Function, material compatibility, adequate ratings, proper installation, operation, and maintenance are the responsibilities of the system designer and user. Caution: Do not mix or interchange valve components with those of other manufacturers.