

Product Category

H812-06-04-06-S

Part Description

Tube to Male Pipe Thread Run Tee Assembly

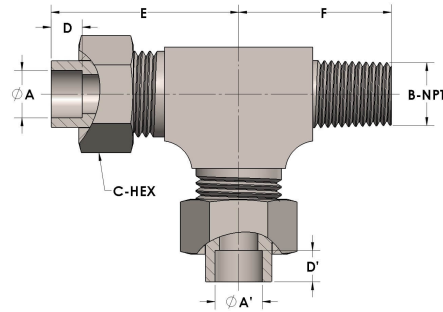

## DIMENSIONS

A	0.380
A'	0.380
B-NPT	1/4" - 18
C-HEX	0.81
D	0.250
D'	0.250
E	1.50
F	1.06

## GENERAL

Pressure Rating	4500 PSI
Assembly Material	Carbon Steel, ASTM A108
O-Ring Material	Viton® Fluorocarbon Type 1, Class 2 (90 durometer)
Connection 1 Type	Female Tube Socket
Connection 1 Size	3/8" Tube O.D. (-06)
Connection 3 Type	Female Tube Socket
Connection 3 Size	3/8" Tube O.D. (-06)