

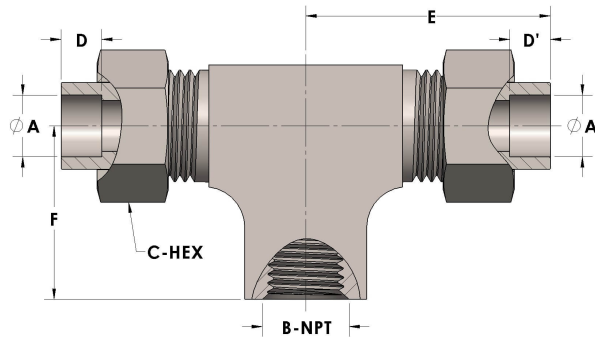

Product Category
Part Description

H813-06-06-04-M
Tube to Female Pipe Thread Branch Tee Assembly



DIMENSIONS

A	0.380
A"	0.380
B-NPT	1/4" - 18
C-HEX	0.81
D	0.250
D"	0.250
E	1.50
F	1.06

GENERAL

Pressure Rating	4500 PSI
Tailpiece Material	Monel®, ASTM B164, UNS N04405
Threadpiece Material	Monel®, ASTM B564, UNS N04400
O-Ring Material	Viton® Fluorocarbon Type 1, Class 2 (90 durometer)
Connection 1 Type	Female Tube Socket
Connection 1 Size	3/8" Tube O.D. (-06)
Connection 2 Type	Female Tube Socket
Connection 2 Size	3/8" Tube O.D. (-06)

The complete catalog contents must be reviewed to ensure that the system designer and user make a safe product selection. When selecting products, the total system design must be considered to ensure safe, trouble-free performance. Function, material compatibility, adequate ratings, proper installation, operation, and maintenance are the responsibilities of the system designer and user. Caution: Do not mix or interchange valve components with those of other manufacturers.