

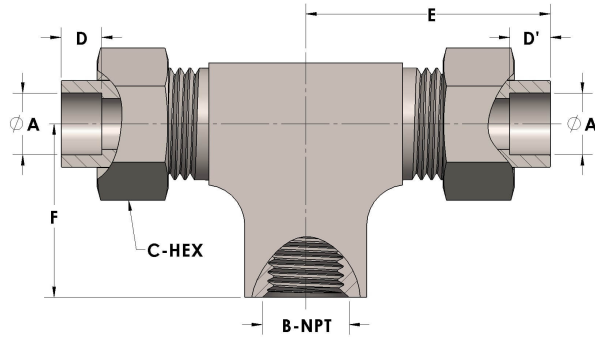

Product Category
Part Description

H813-12-12-12-S
Tube to Female Pipe Thread Branch Tee Assembly



DIMENSIONS

A	0.750
A"	0.750
B-NPT	3/4" - 14
C-HEX	1.38
D	0.440
D"	0.440
E	2.25
F	1.56

GENERAL

Pressure Rating	4500 PSI
Assembly Material	Carbon Steel, ASTM A108
O-Ring Material	Viton® Fluorocarbon Type 1, Class 2 (90 durometer)
Connection 1 Type	Female Tube Socket
Connection 1 Size	3/4" Tube O.D. (-12)
Connection 2 Type	Female Tube Socket
Connection 2 Size	3/4" Tube O.D. (-12)

The complete catalog contents must be reviewed to ensure that the system designer and user make a safe product selection. When selecting products, the total system design must be considered to ensure safe, trouble-free performance. Function, material compatibility, adequate ratings, proper installation, operation, and maintenance are the responsibilities of the system designer and user. Caution: Do not mix or interchange valve components with those of other manufacturers.