

Product Category

H814-12-12-12-S

Part Description

Tube to Female Pipe Thread Run Tee Assembly

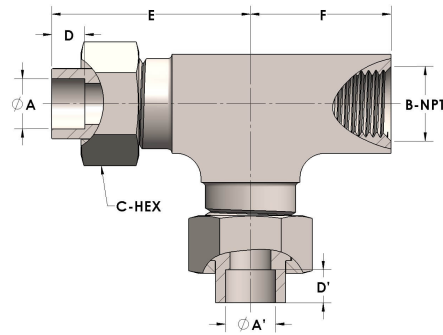

DIMENSIONS

A	0.750
A'	0.750
B-NPT	3/4" - 14
C-HEX	1.38
D	0.440
D'	0.440
E	2.25
F	1.56

GENERAL

Pressure Rating	4500 PSI
Assembly Material	Carbon Steel, ASTM A108
O-Ring Material	Viton® Fluorocarbon Type 1, Class 2 (90 durometer)
Connection 1 Type	Female Tube Socket
Connection 1 Size	3/4" Tube O.D. (-12)
Connection 3 Type	Female Tube Socket
Connection 3 Size	3/4" Tube O.D. (-12)