

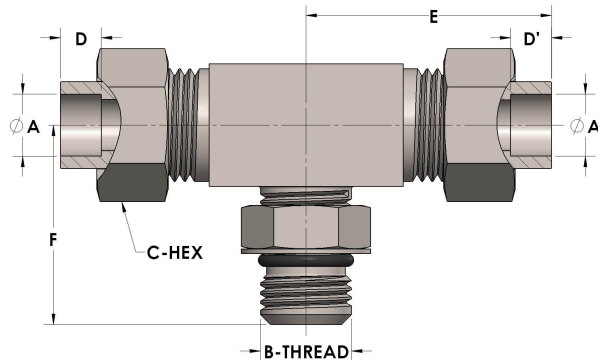

Product Category
Part Description

H815-10-10-10-M
Tube to Male Straight Thread Branch Tee Assembly



DIMENSIONS

A	0.630
A"	0.630
B-THREAD	.875" - 14UNF
C-HEX	1.13
D	0.380
D"	0.380
E	2.06
F	1.69

GENERAL

Pressure Rating	6000 PSI
Tailpiece Material	Monel®, ASTM B164, UNS N04405
Threadpiece Material	Monel®, ASTM B564, UNS N04400
O-Ring Material	Viton® Fluorocarbon Type 1, Class 2 (90 durometer)
Connection 1 Type	Female Tube Socket
Connection 1 Size	5/8" Tube O.D. (-10)
Connection 2 Type	Female Tube Socket
Connection 2 Size	5/8" Tube O.D. (-10)

The complete catalog contents must be reviewed to ensure that the system designer and user make a safe product selection. When selecting products, the total system design must be considered to ensure safe, trouble-free performance. Function, material compatibility, adequate ratings, proper installation, operation, and maintenance are the responsibilities of the system designer and user. Caution: Do not mix or interchange valve components with those of other manufacturers.