

Product Category

H819-06-SS316L

Part Description

Direct Socketweld/Braze Cross (Tube)

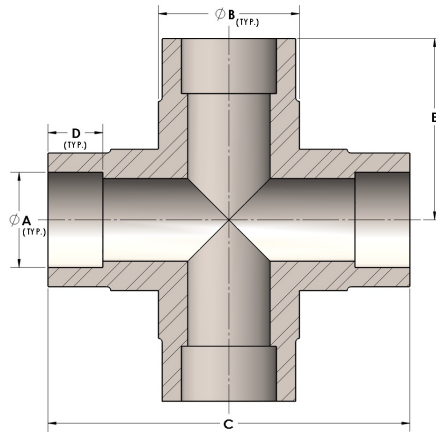

DIMENSIONS

A	0.380
B	0.63
C	1.63
D	0.250
E	0.81
F	1.13

GENERAL

Pressure Rating	6000 PSI
Fitting Material	316/L Stainless Steel, ASTM A276, UNS S31600/03