

Product Category

H820-12-10-SS316L

Part Description

Socketweld/braze Tube Elbow Assembly

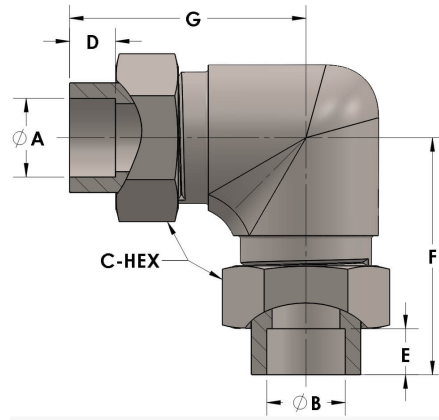

DIMENSIONS

A	0.750
B	0.63
C-HEX	1.38
D	0.440
E	0.38
F	2.19
G	2.25

GENERAL

Pressure Rating	4500 PSI
Assembly Material	316/L Stainless Steel, ASTM A276, UNS S31600/03
O-Ring Material	Viton® Fluorocarbon Type 1, Class 2 (90 durometer)
Connection 1 Type	Female Tube Socket
Connection 1 Size	3/4" Tube O.D. (-12)
Connection 2 Type	Female Tube Socket
Connection 2 Size	5/8" Tube O.D. (-10)