

Product Category

H823-10-10-S

Part Description

Tube to Male Straight Thread Elbow Assembly

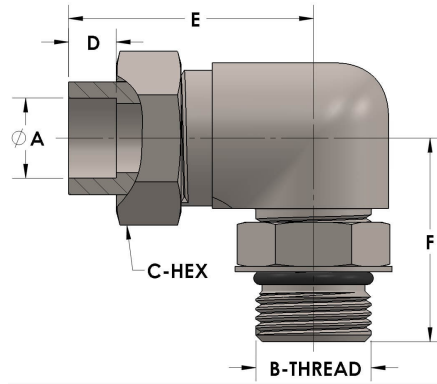

DIMENSIONS

A	0.630
B-THREAD	.875" - 14UNF
C-HEX	1.13
D	0.380
E	2.06
F	1.69

GENERAL

Pressure Rating	4500 PSI
Assembly Material	Carbon Steel, ASTM A108
O-Ring Material	Viton® Fluorocarbon Type 1, Class 2 (90 durometer)
Connection 1 Type	Female Tube Socket
Connection 1 Size	5/8" Tube O.D. (-10)
Connection 2 Type	Male Straight Thread
Connection 2 Size	.875" - 14UNF (-10)