

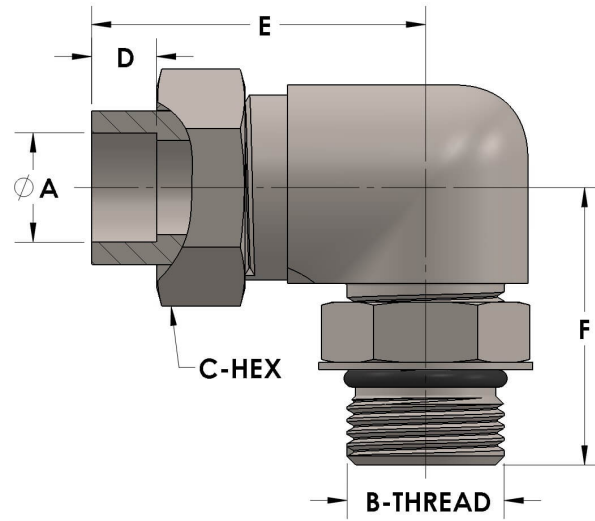

Product Category
Part Description

H823-12-12-SS316L
Tube to Male Straight Thread Elbow Assembly



DIMENSIONS

A	0.750
B-THREAD	1.063" - 12UN
C-HEX	1.38
D	0.440
E	2.25
F	1.94

GENERAL

Pressure Rating	6000 PSI
Assembly Material	316/L Stainless Steel, ASTM A276, UNS S31600/03
O-Ring Material	Viton® Fluorocarbon Type 1, Class 2 (90 durometer)
Connection 1 Type	Female Tube Socket
Connection 1 Size	3/4" Tube O.D. (-12)
Connection 2 Type	Male Straight Thread
Connection 2 Size	1.063" - 12UN (-12)

The complete catalog contents must be reviewed to ensure that the system designer and user make a safe product selection. When selecting products, the total system design must be considered to ensure safe, trouble-free performance. Function, material compatibility, adequate ratings, proper installation, operation, and maintenance are the responsibilities of the system designer and user. Caution: Do not mix or interchange valve components with those of other manufacturers.