

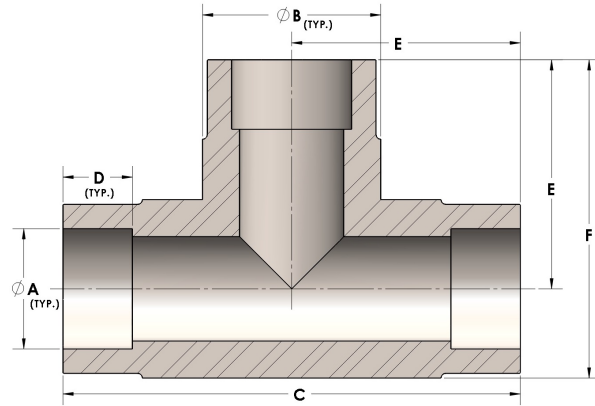

Product Category
Part Description

H830-32-CUNI
Direct Socketweld/Braze Tee (Tube)



DIMENSIONS

A	2.000
B	2.75
C	5.75
D	0.880
E	2.88
F	4.25

GENERAL

Pressure Rating	3000 PSI
Fitting Material	Copper Nickel 70/30, MIL-C--15726F, UNS C71500