

Product Category

H840-04-S

Part Description

Direct Socketweld/Braze 90° Elbow (Tube)

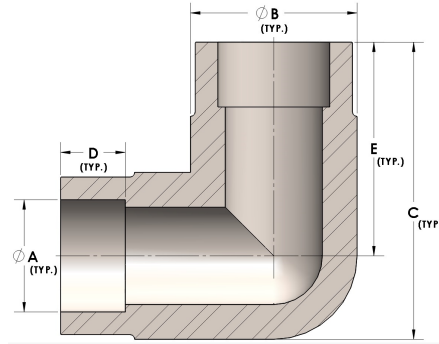

DIMENSIONS

A	0.250
B	0.63
C	1.13
D	0.190
E	0.81

GENERAL

Pressure Rating	6000 PSI
Fitting Material	Carbon Steel, ASTM A108