

Product Category

H840-06-CUNI

Part Description

Direct Socketweld/Braze 90° Elbow (Tube)

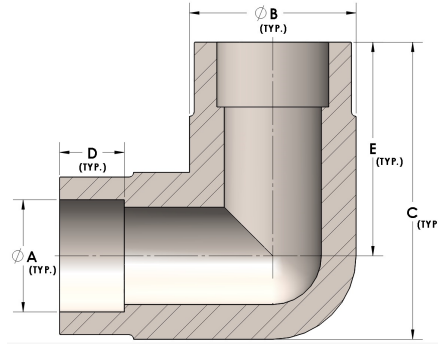

DIMENSIONS

A	0.380
B	0.63
C	1.13
D	0.250
E	0.81

GENERAL

Pressure Rating	3000 PSI
Fitting Material	Copper Nickel 70/30, MIL-C--15726F, UNS C71500