



Product Category

H840-12-M

Part Description

Direct Socketweld/Braze 90° Elbow (Tube)

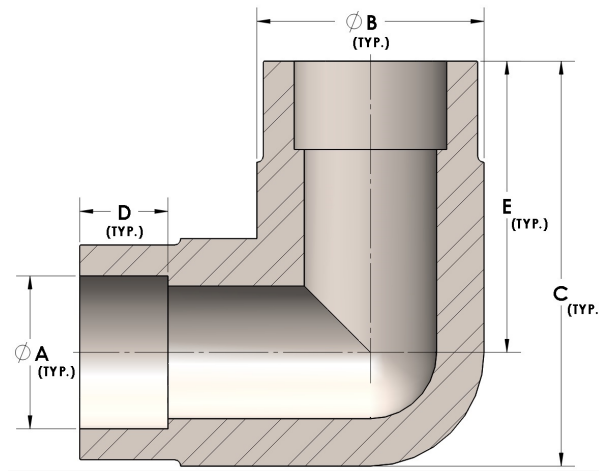

DIMENSIONS

A	0.750
B	1.13
C	2.00
D	0.440
E	1.44

GENERAL

Pressure Rating	4500 PSI
Fitting Material	Monel®, ASTM B164, UNS N04405

The complete catalog contents must be reviewed to ensure that the system designer and user make a safe product selection. When selecting products, the total system design must be considered to ensure safe, trouble-free performance. Function, material compatibility, adequate ratings, proper installation, operation, and maintenance are the responsibilities of the system designer and user. Caution: Do not mix or interchange valve components with those of other manufacturers.