

Product Category

H840-16-SS316L

Part Description

Direct Socketweld/Braze 90° Elbow (Tube)

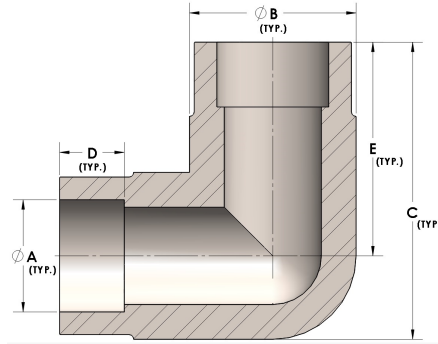

DIMENSIONS

A	1.000
B	1.63
C	2.25
D	0.500
E	1.56

GENERAL

Pressure Rating	4500 PSI
Fitting Material	316/L Stainless Steel, ASTM A276, UNS S31600/03