

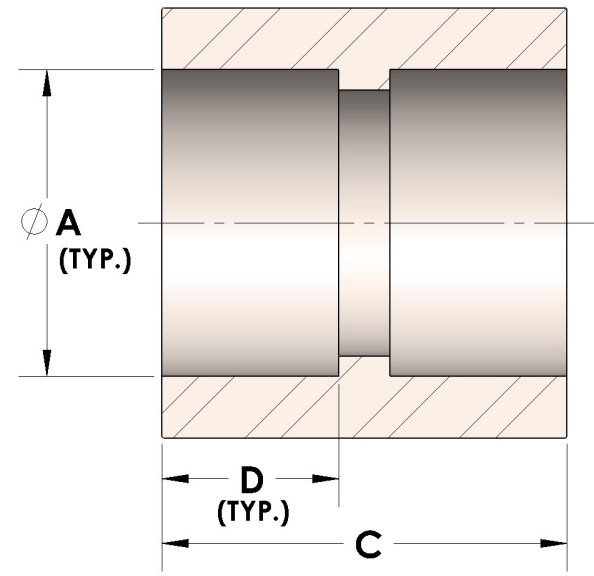

Product Category
Part Description

H847-04-S
Direct Socketweld/Braze Coupling (Tube)



DIMENSIONS

A	0.250
C	0.44
D	0.190

GENERAL

Pressure Rating	6000 PSI
Fitting Material	Carbon Steel, ASTM A108

cpvmfg.com | 484.731.4010

The complete catalog contents must be reviewed to ensure that the system designer and user make a safe product selection. When selecting products, the total system design must be considered to ensure safe, trouble-free performance. Function, material compatibility, adequate ratings, proper installation, operation, and maintenance are the responsibilities of the system designer and user. Caution: Do not mix or interchange valve components with those of other manufacturers.