

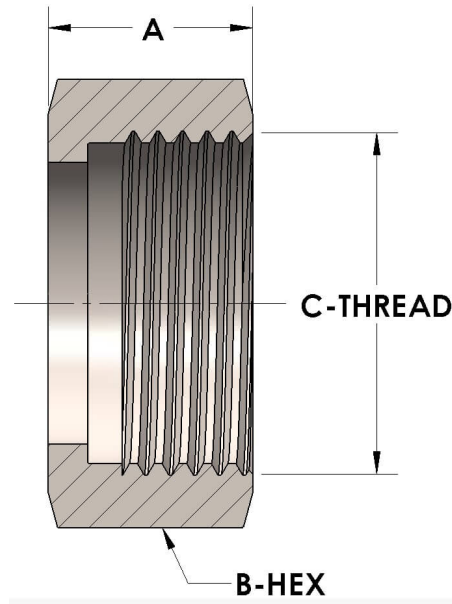

Product Category
Part Description

H850N-08-BR
Union Nut



DIMENSIONS

A	0.500
B-HEX	0.94
C-THREAD	.813" - 16UN

GENERAL

Pressure Rating	3000 PSI
Union Nut Material	Naval Brass, ASTM B21, UNS C46400

The complete catalog contents must be reviewed to ensure that the system designer and user make a safe product selection. When selecting products, the total system design must be considered to ensure safe, trouble-free performance. Function, material compatibility, adequate ratings, proper installation, operation, and maintenance are the responsibilities of the system designer and user. Caution: Do not mix or interchange valve components with those of other manufacturers.