

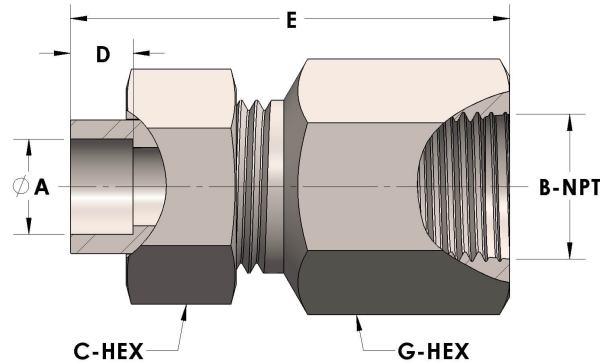

Product Category
Part Description

H853-06-06-M
Tube to Female Pipe Thread Union Assembly



DIMENSIONS

A	0.380
B-NPT	3/8" - 18
C-HEX	0.94
D	0.250
E	1.94
G-HEX	0.88

GENERAL

Pressure Rating	6000 PSI
Assembly Material	Monel®, ASTM B164, UNS N04405
O-Ring Material	Viton® Fluorocarbon Type 1, Class 2 (90 durometer)
Connection 1 Type	Female Tube Socket
Connection 1 Size	3/8" Tube O.D. (-06)
Connection 2 Type	Female Pipe Thread
Connection 2 Size	3/8" NPT (-06)