

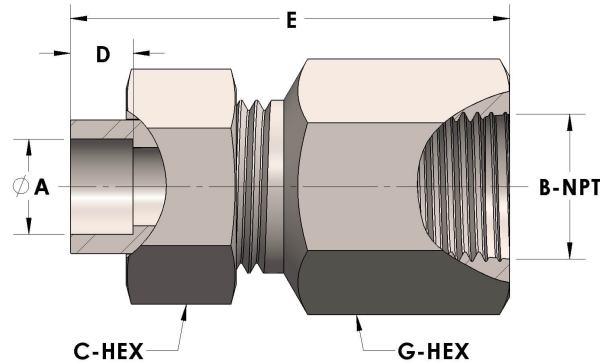

Product Category
Part Description

H853-06-08-SS316L
Tube to Female Pipe Thread Union Assembly



DIMENSIONS

A	0.380
B-NPT	1/2" - 14
C-HEX	1.13
D	0.250
E	2.25
G-HEX	1.13

GENERAL

Pressure Rating	4500 PSI
Assembly Material	316/L Stainless Steel, ASTM A276, UNS S31600/03
O-Ring Material	Viton® Fluorocarbon Type 1, Class 2 (90 durometer)
Connection 1 Type	Female Tube Socket
Connection 1 Size	3/8" Tube O.D. (-06)
Connection 2 Type	Female Pipe Thread
Connection 2 Size	1/2" NPT (-08)