

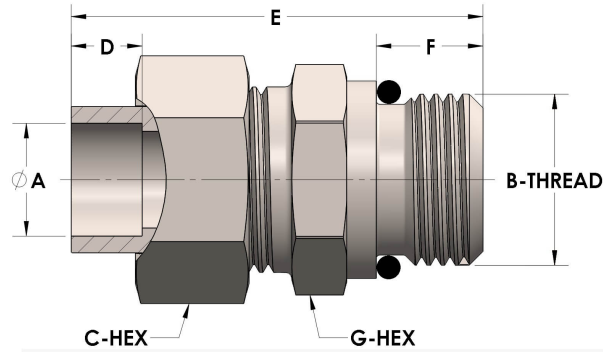

**Product Category**  
**Part Description**

H859-04-06-SS316L  
Tube to Male Straight Thread Union Assembly



## DIMENSIONS

A	0.250
B-THREAD	.563" - 18UNF
C-HEX	0.81
D	0.190
E	1.56
G-HEX	0.75

## GENERAL

Pressure Rating	6000 PSI
Assembly Material	316/L Stainless Steel, ASTM A276, UNS S31600/03
O-Ring Material	Viton® Fluorocarbon Type 1, Class 2 (90 durometer)
Connection 1 Type	Female Tube Socket
Connection 1 Size	1/4" Tube O.D. (-04)
Connection 2 Type	Male Straight Thread
Connection 2 Size	.563" - 18UNF (-06)