

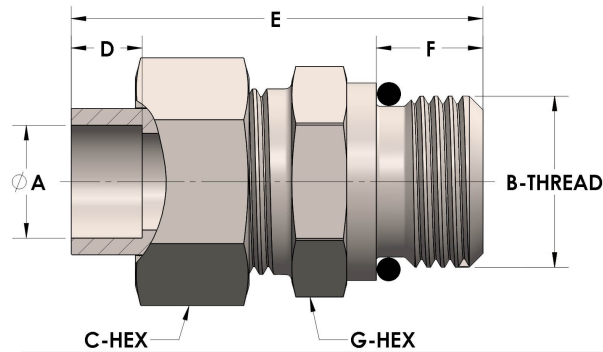

Product Category
Part Description

H859-06-06-M
Tube to Male Straight Thread Union Assembly



DIMENSIONS

A	0.380
B-THREAD	.563" - 18UNF
C-HEX	0.81
D	0.250
E	1.63
G-HEX	0.75

GENERAL

Pressure Rating	6000 PSI
Assembly Material	Monel®, ASTM B164, UNS N04405
O-Ring Material	Viton® Fluorocarbon Type 1, Class 2 (90 durometer)
Connection 1 Type	Female Tube Socket
Connection 1 Size	3/8" Tube O.D. (-06)
Connection 2 Type	Male Straight Thread
Connection 2 Size	.563" - 18UNF (-06)