

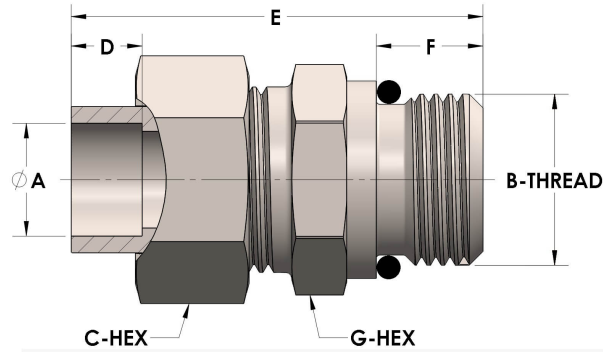

Product Category  
Part Description

H859-08-10-S  
Tube to Male Straight Thread Union Assembly



## DIMENSIONS

A	0.500
B-THREAD	.875" - 14UNF
C-HEX	1.13
D	0.310
E	2.00
G-HEX	1.06

## GENERAL

Pressure Rating	4500 PSI
Assembly Material	Carbon Steel, ASTM A108
O-Ring Material	Viton® Fluorocarbon Type 1, Class 2 (90 durometer)
Connection 1 Type	Female Tube Socket
Connection 1 Size	1/2" Tube O.D. (-08)
Connection 2 Type	Male Straight Thread
Connection 2 Size	.875" - 14UNF (-10)