

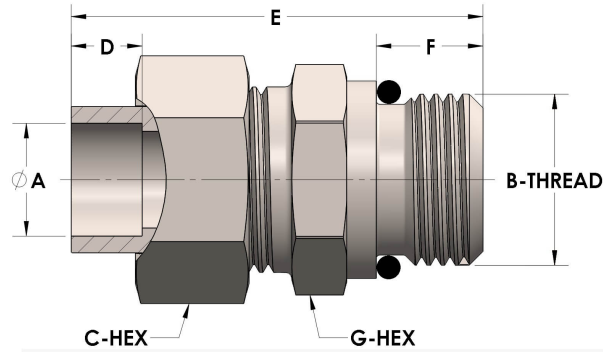

**Product Category**  
**Part Description**

H859-10-10-SS316L  
Tube to Male Straight Thread Union Assembly



## DIMENSIONS

A	0.630
B-THREAD	.875" - 14UNF
C-HEX	1.13
D	0.380
E	2.06
G-HEX	1.06

## GENERAL

Pressure Rating	4500 PSI
Assembly Material	316/L Stainless Steel, ASTM A276, UNS S31600/03
O-Ring Material	Viton® Fluorocarbon Type 1, Class 2 (90 durometer)
Connection 1 Type	Female Tube Socket
Connection 1 Size	5/8" Tube O.D. (-10)
Connection 2 Type	Male Straight Thread
Connection 2 Size	.875" - 14UNF (-10)