

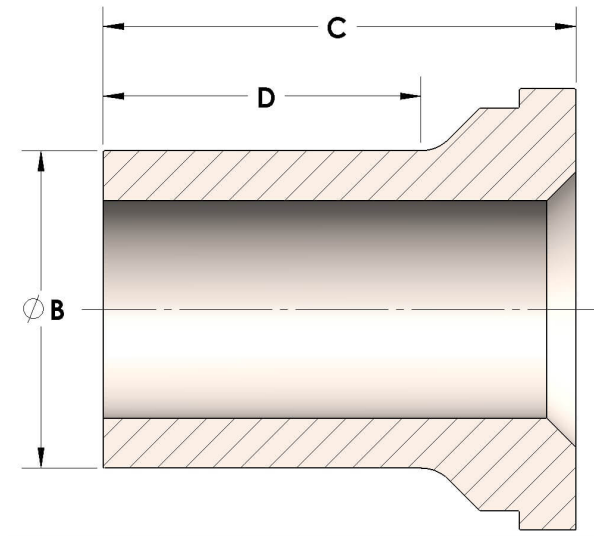

Product Category  
Part Description

H863R-10-S  
Male Tube Weld Tailpiece



## DIMENSIONS

B	0.63
C	1.19
D	0.810

## GENERAL

Pressure Rating	6000 PSI
Tailpiece Material	Carbon Steel, ASTM A108

The complete catalog contents must be reviewed to ensure that the system designer and user make a safe product selection. When selecting products, the total system design must be considered to ensure safe, trouble-free performance. Function, material compatibility, adequate ratings, proper installation, operation, and maintenance are the responsibilities of the system designer and user. Caution: Do not mix or interchange valve components with those of other manufacturers.