

Product Category

H863R-16-S

Part Description

Male Tube Weld Tailpiece

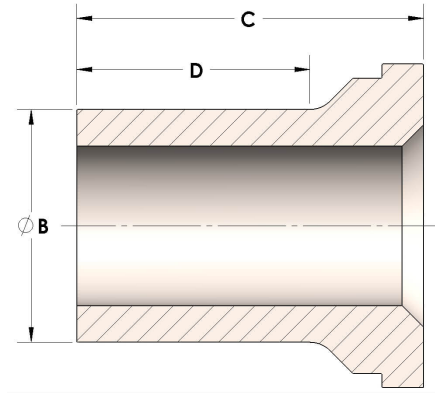

DIMENSIONS

B	1.00
C	1.50
D	1.060

GENERAL

Pressure Rating	6000 PSI
Tailpiece Material	Carbon Steel, ASTM A108