

Product Category

H863R-24-M

Part Description

Male Tube Weld Tailpiece

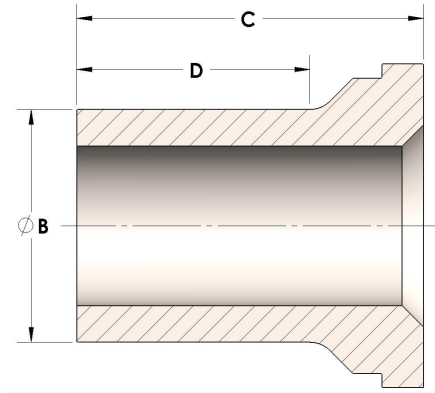

DIMENSIONS

B	1.50
C	1.88
D	1.380

GENERAL

Pressure Rating	4500 PSI
Tailpiece Material	Monel®, ASTM B164, UNS N04405