

Product Category

H863R-24-S

Part Description

Male Tube Weld Tailpiece

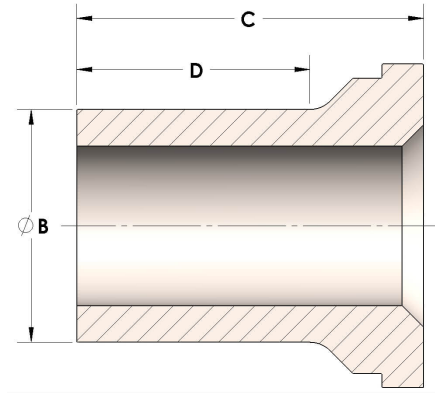

DIMENSIONS

B	1.50
C	1.88
D	1.380

GENERAL

Pressure Rating	3000 PSI
Tailpiece Material	Carbon Steel, ASTM A108