

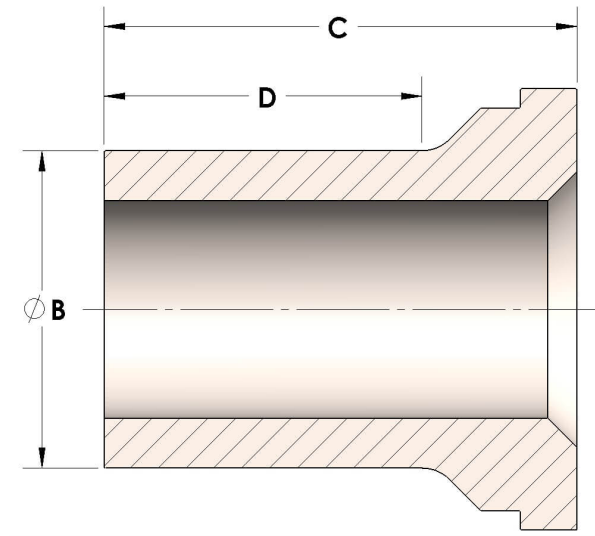

**Product Category**  
**Part Description**

H863R-32-SS316L  
Male Tube Weld Tailpiece



## DIMENSIONS

<b>B</b>	2.00
<b>C</b>	2.25
<b>D</b>	1.560

## GENERAL

<b>Pressure Rating</b>	3000 PSI
<b>Tailpiece Material</b>	316/L Stainless Steel, ASTM A276, UNS S31600/03

The complete catalog contents must be reviewed to ensure that the system designer and user make a safe product selection. When selecting products, the total system design must be considered to ensure safe, trouble-free performance. Function, material compatibility, adequate ratings, proper installation, operation, and maintenance are the responsibilities of the system designer and user. Caution: Do not mix or interchange valve components with those of other manufacturers.