

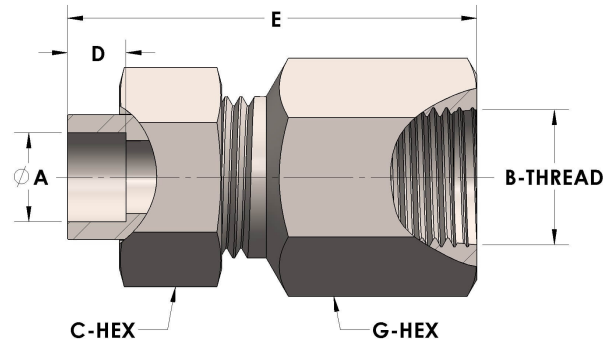

Product Category
Part Description

H864-04-06-M
Tube to Female Straight Thread Union Assembly



DIMENSIONS

A	0.250
B-THREAD	.563" - 18UNF
C-HEX	0.81
D	0.190
E	1.69
G-HEX	0.88

GENERAL

Pressure Rating	6000 PSI
Assembly Material	Monel®, ASTM B164, UNS N04405
O-Ring Material	Viton® Fluorocarbon Type 1, Class 2 (90 durometer)
Connection 1 Type	Female Tube Socket
Connection 1 Size	1/4" Tube O.D. (-04)
Connection 2 Type	Female Straight Thread
Connection 2 Size	.563" - 18UNF (-06)