

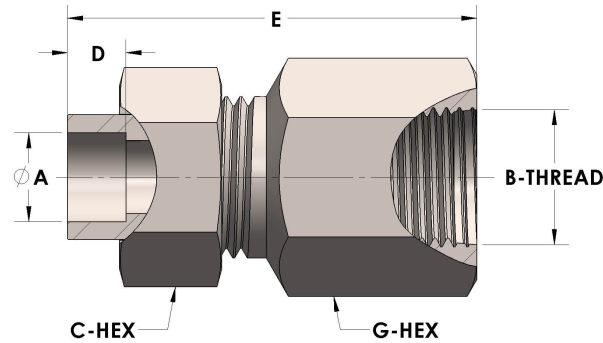

Product Category
Part Description

H864-04-08-SS316L
Tube to Female Straight Thread Union Assembly



DIMENSIONS

A	0.250
B-THREAD	.750" - 16UNF
C-HEX	0.94
D	0.190
E	1.88
G-HEX	1.06

GENERAL

Pressure Rating	6000 PSI
Assembly Material	316/L Stainless Steel, ASTM A276, UNS S31600/03
O-Ring Material	Viton® Fluorocarbon Type 1, Class 2 (90 durometer)
Connection 1 Type	Female Tube Socket
Connection 1 Size	1/4" Tube O.D. (-04)
Connection 2 Type	Female Straight Thread
Connection 2 Size	.750" - 16UNF (-08)