



Product Category

H864-06-10-M

Part Description

Tube to Female Straight Thread Union Assembly

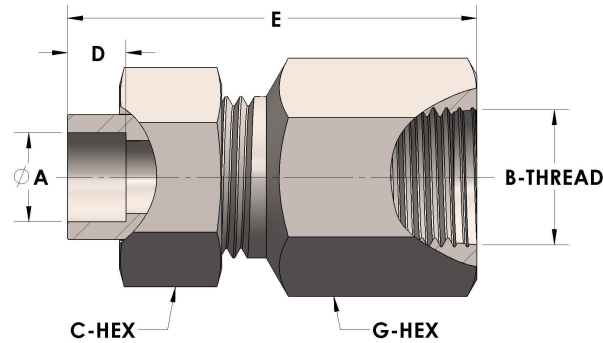

DIMENSIONS

A	0.380
B-THREAD	.875" - 14UNF
C-HEX	1.13
D	0.250
E	2.25
G-HEX	1.13

GENERAL

Pressure Rating	6000 PSI
Assembly Material	Monel®, ASTM B164, UNS N04405
O-Ring Material	Viton® Fluorocarbon Type 1, Class 2 (90 durometer)
Connection 1 Type	Female Tube Socket
Connection 1 Size	3/8" Tube O.D. (-06)
Connection 2 Type	Female Straight Thread
Connection 2 Size	.875" - 14UNF (-10)